

## ACCESSORIES

### Car Adapter

Enables you to re-charge your battery with your vehicle's electrical system.



Part No. 900507

### Battery Cell

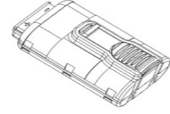

Part No. 018880

### Battery Charger

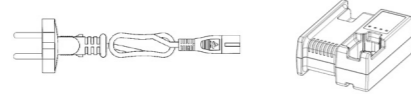

Part No. 018881 (EU)  
018882 (UK)

### Cable



Part No. 018885 (EU)  
018886 (UK)

### 9/64" Hex Key

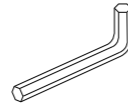

Part No. 900736

### Clear Safety Glasses



Part No. 014121

### Cordless Tool Cleaner

deal cleaner for all Paslode® Tools

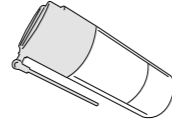

Part No. 012007

### Paslode® Cordless Lubricating Oil

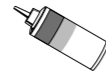

Part No. 013075

### Tool Case

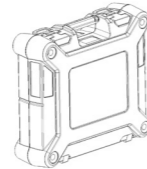

Part No. 014980

### Cleaning Kit (Blister)

Contains all the necessary to clean any Impulse tool



Part No. 013690

# Paslode®

## Impulse®

Part No. 018607 (EU)  
Part No. 018608 (UK)



## IM45 GN Lithium

### IMPORTANT! DO NOT DESTROY

Always refer to operating and safety instructions (#019238 & #014749) for detailed information on this tool. It is the customer's responsibility to have all operators and service personnel read and understand this information.

### TOOL SCHEMATIC AND PARTS



An Illinois Tool Works Company  
Route de Lyon - BP 104  
F - 26501 Bourg Les Valence - Cedex France

019240-04  
10/19

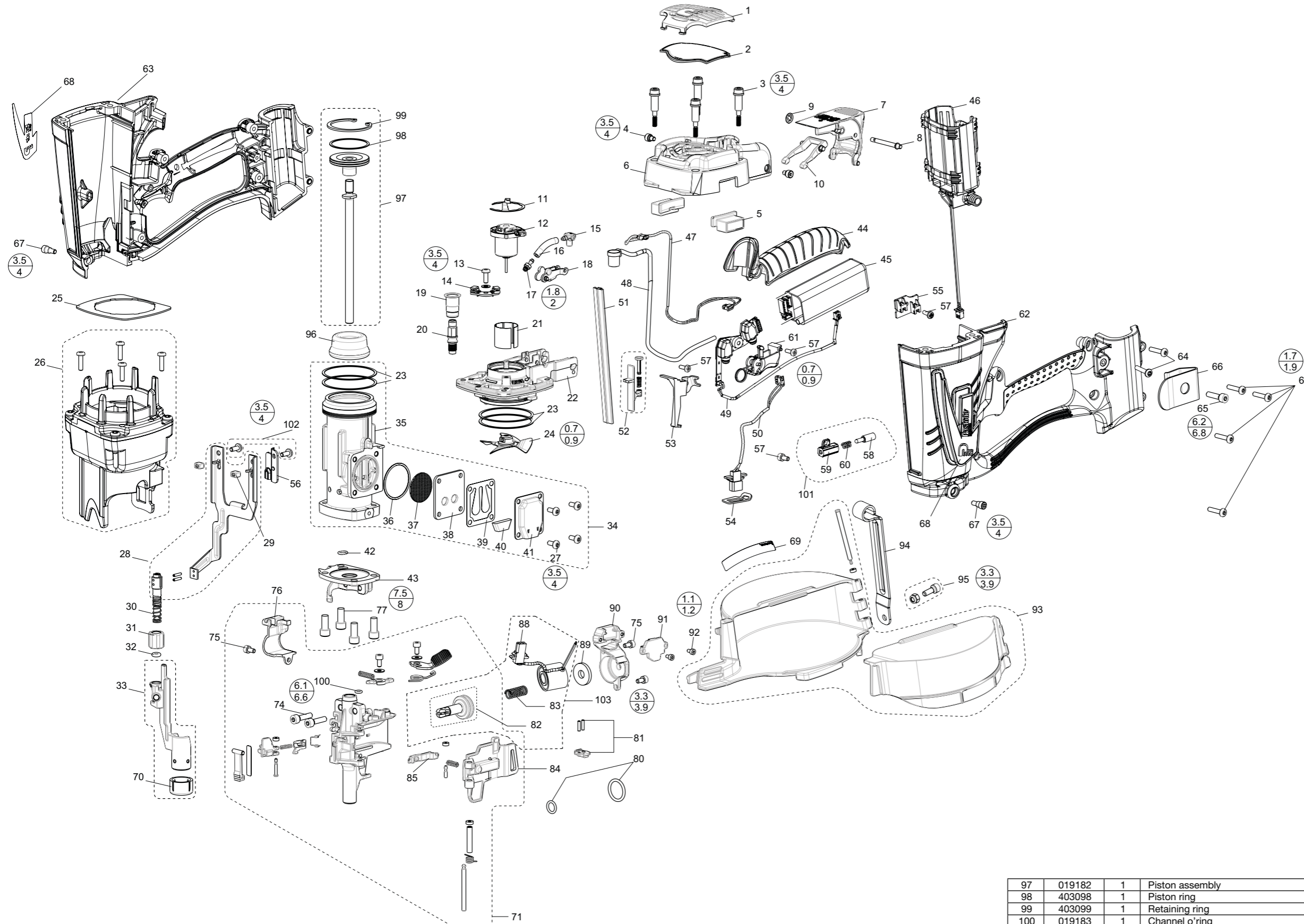

TORQUE VALUES	
MIN	N.m
MAX	

97	019182	1	Piston assembly
98	403098	1	Piston ring
99	403099	1	Retaining ring
100	019183	1	Channel o'ring
101	019272	1	Lockout assembly
102	019188	1	Torx Machine screw 8-32x3/8
103	019193	1	Magnet/Piston/Spring assembly

1	904555	1	Grille
2	900648	1	Filter
3	901064	4	Screw, SHC Shoulder 8-32x1 3/8
4	904557	2	Screw SHC
5	904597	2	Wear Pad-upper
6	904551	1	Cop Cylinder Head
7	904550	1	Fuel door
8	902230	1	Pin-Fuel door
9	902235	1	Clip fuel door
10	019187	1	Dosing lever
11	901119	1	Retaining ring, motor
12	901382	1	Motor assembly
13	900596	1	SEMS Screw torx
14	900739	1	Circuit board
15	902406	1	Fuel block
16	904546	1	Fuel tube
17	904517	1	Fuel bard
18	904521	1	Pivot arm
19	900785	1	Insulator
20	900714	1	Spark plug assembly
21	401356	1	Motor sleeve
22	904504	1	Cylinder head
23	900612	4	Seal ring
24	900709	1	Fan assembly
25	900700	1	Air dam
26	904721	1	Combustion chamber assembly
27	405140	4	Screw torx
28	019151	1	Upper yoke assembly
29	900707	2	Bumper yoke
30	904594	1	Combustion chamber spring
31	019152	1	Knob
32	014415	1	O'ring knob
33	019153	1	Probe assembly
34	904581	1	Cylinder assembly
35	904503	1	Cylinder sleeve
36	900616	1	O'ring exhaust
37	901089	1	Disk filter
38	900665	1	Reed plate
39	900664	1	Reed valve
40	900609	1	Muffler
41	900668	1	Cover muffler
42	904523	1	O'ring, sleeve
43	019154	1	Bottom plate
44	901044	1	Soft grip
45	904717	1	Spark unit
46	018219	1	Battery case
47	904562	1	Fan motor harness
48	904567	1	Spark plug wire assembly
49	904709	1	Molded circuit assembly
50	904561	1	Wire harness
51	900620	1	Front channel
52	900726	1	Slide switch assembly
53	904532	1	Wire clip
54	904558	1	Connector bracket
55	904710	1	PCB assembly
56	904703	1	Lockout bracket
57	404702	4	Screw 8-16 x 3/4"
58	904704	1	Lockout pin
59	904705	1	Lockout body
60	904707	1	Spring lockout pin
61	904714	1	Trigger assembly
62	904701	1	Handle left
63	904702	1	Handle right
64	901066	6	Screw 8-16 x 3/4"
65	004618	1	Screw insert belt hook
66	904541	1	Belt hook
67	900792	2	Shoulder screw 8-32
68	018923	1	Handle labels logo assembly
69	019271	1	Name plate
70	576340	2	No mar tip
71	019192	1	Nose assembly
74	019162	2	Screw CHC M5-20
75	576314	3	Screw CHC H504070B08
76	576346	1	Feed Cover
77	904576	4	Screw 1/4 - 20 x 5/8"
80	019167	1	Feed piston o'rings
81	019168	1	Feed powl & pins
82	019186	1	Feed piston assembly
83	019191	1	Feed piston spring
84	576348	1	Door
85	576331	1	Claw pad
88	019189	1	Terminated magnet assembly
89	904540	1	Bumper claw piston
90	019175	1	Magnet support
91	019176	1	Magnet cover plug
92	019177	2	Screw plastite 3x8
93	019178	1	Magazine assembly
94	904719	1	Magazine bracket
95	019181	1	Magazine screw + bolt
96	900680	1	Bumper